

EZ6IC

6" UNIVERSAL IC HOUSING W/ LOOSE SOCKET & WAGO CONNECTORS

BAFFLE TRIM



6"

INCANDESCENT

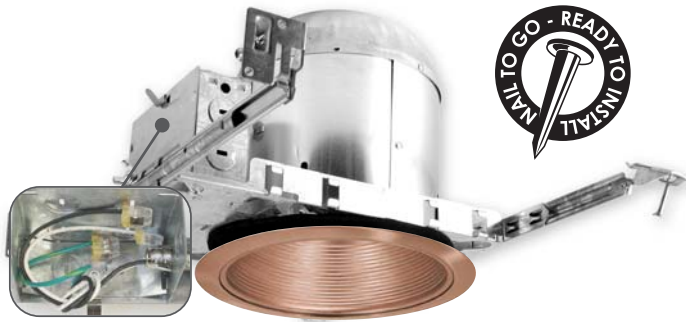

DESCRIPTION:

For new construction. Thermally protected, IC rated specification grade recessed housing. Accommodates up to 75W R30, 75W PAR30, 65W BR40, 65W BR30, 65W PAR38, 50W PAR30 and 60W A19 lamps. Furnished with preinstalled adjustable bar hangers. Junction box is provided with four 1/2" KOs, one 3/4" KO and four Romex knockouts with strain relief.

LAMP WATTAGE: (1) Maximum **75W R30, 75W PAR30, 65W BR40, 65W BR30, 65W PAR38, 50W PAR30, 60W A19**

* Maximum lamp wattage may vary based on trim.

SPECIFICATION:

A. HOUSING - Die-formed all aluminum construction for maximum heat dissipation and rust protection. Adjusts vertically in plaster frame to accommodate 1/2" to 1-3/8" ceiling.

B. SOCKET - Medium base screw shell porcelain socket that attaches directly to the AF series trims.

C. BAR HANGERS - Preinstalled bar hangers allow housing to be positioned and locked at any point within a 24" joist span. They can be positioned on either the long or short axis of the housing and can be shortened for 12" joists. They contain a double-headed real nail for secure attachment into the joist. Bar hanger nails are installed on a 20° downward angle for better contact, and the 90° pivoting mounting plate makes installation fast and accurate. Bar hangers can fit onto T-Bar spline with additional slots and holes for special mounting methods if necessary.

D. JUNCTION BOX - UL and ETL listed for through-branch circuit wiring and has four 1/2" KOs, one 3/4" KO and four Romex knockouts with true pry-out slots and strain clamps.

E. THERMAL PROTECTION - Standard thermal protection device guards against improper installation, overlamping and misuse of insulation material.

UL and C-UL listed
ETL and C-ETL listed
for Damp location.

UL listed
ETL listed
for Feed Through wiring.

UL listed
ETL listed
for Direct Contact with Insulation.



Gasket to prevent air flow from heated or air conditioned spaces.

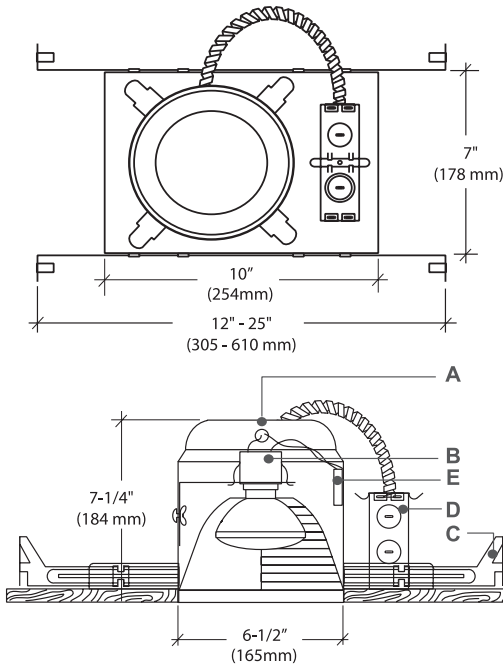

ORDERING INFORMATION, PLEASE SPECIFY:

TYPE	OPTION(S)	TRIM TYPE			BAFFLE	TRIM RING
EZ6IC	AIR SHUT	<input type="checkbox"/> AF637	<input type="checkbox"/> AF649	<input type="checkbox"/> B673	<input type="checkbox"/> W	<input type="checkbox"/> WH
	AT	<input type="checkbox"/> AF631	<input type="checkbox"/> B609	<input type="checkbox"/> AF635	<input type="checkbox"/> P	<input type="checkbox"/> BK
	WAGO	<input type="checkbox"/> AF639	<input type="checkbox"/> B646	<input type="checkbox"/> AF636	<input type="checkbox"/> SN	<input type="checkbox"/> SN
	W	<input type="checkbox"/> AF640	<input type="checkbox"/> B616	<input type="checkbox"/> AF637	<input type="checkbox"/> CP	<input type="checkbox"/> CP
					<input type="checkbox"/> BZ	<input type="checkbox"/> CH
						<input type="checkbox"/> PB
						<input type="checkbox"/> BZ

Specified:
EZ6IC - AT - W - - -
 TYPE OPTION(1) OPTION(2) TRIM TYPE BAFFLE TRIM RING
 (Sample of Catalog Number: **EZ6IC-AT-B630-W-WH**)

SPECIFIED BY:

TYPE: _____ JOB NAME: _____



Tel: 323-888-1973 • 877-375-5555 / Fax: 323-888-1977 • 877-375-3333
 www.iuseelite.com • E-mail: sales@iuseelite.com



AF637 _____
SELF-FLANGE AIR-SHUT BAFFLE

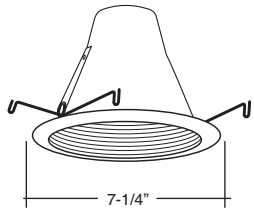

NEW CLIP DESIGN

MAX. LAMP WATT:
75W R30, 75W PAR30, 65W BR30,
50W PAR30, 60W A19

AVAILABLE COLOR COMBINATIONS:
CP-CP, SN-SN, W-WH,
P-WH, P-BK, BZ-BZ

AF631 _____
SELF-FLANGE AIR-SHUT BAFFLE

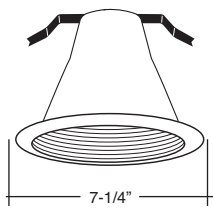

NEW CLIP DESIGN

MAX. LAMP WATT:
75W R30, 75W PAR30, 65W BR30,
50W PAR30, 45W PAR38

AVAILABLE COLOR COMBINATIONS:
CP-CP, SN-SN, W-WH,
P-WH, P-BK, BZ-BZ

AF639 _____
SELF-FLANGE AIR-SHUT BAFFLE

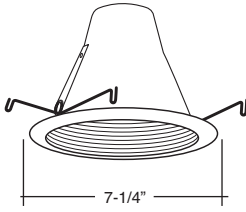

NEW CLIP DESIGN

MAX. LAMP WATT:
75W R30, 75W PAR30, 65W BR30,
50W PAR30, 60W A19

AVAILABLE COLOR COMBINATION:
W-WH (WHITE MATT FINISH)

AF640 _____
DEEP SELF-FLANGE AIR-SHUT BAFFLE

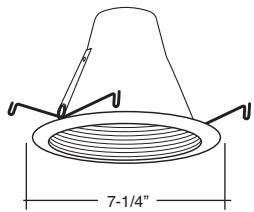

NEW CLIP DESIGN

MAX. LAMP WATT:
75W R30, 75W PAR30, 65W BR40, 65W
BR30, 65W PAR38, 50W PAR30, 60W A19

AVAILABLE COLOR COMBINATION:
W-WH, P-WH

AF649 _____
DEEP SELF-FLANGE AIR-SHUT BAFFLE

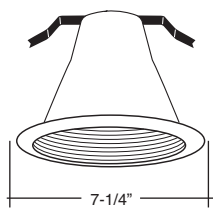

NEW CLIP DESIGN

MAX. LAMP WATT:
75W R30, 75W PAR30, 65W BR40, 65W
BR30, 65W PAR38, 50W PAR30, 60W A19

AVAILABLE COLOR COMBINATIONS:
CP-CP, SN-SN, W-WH,
P-WH, P-BK, BZ-BZ

B609 _____
REGRESSED EYEBALL W/ BAFFLE

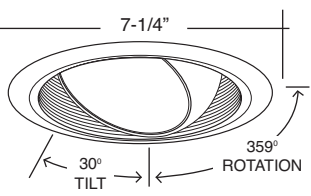

MAX. LAMP WATT:
75W R30/PAR30, 65W BR30, 50W PAR30

BAFFLE:
W, P, SN, CP

RING:
WH, BK, SN, CP, CH, PB

EYEBALL:
WH, BK, SN, CP, CH, PB

B646 _____
EYEBALL WITH BAFFLE

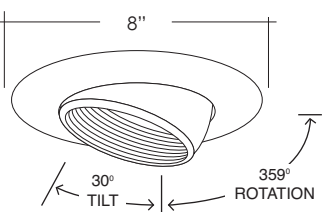

MAX. LAMP WATT:
75W R30, 75W PAR30,
65W BR30, 50W PAR30

BAFFLE:
W, P

RING:
WH

B616 _____
PAR20 REG. EYEBALL W/ BAFFLE (30° TILT)

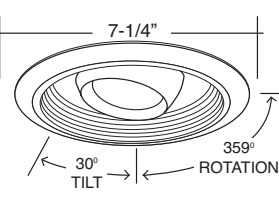

MAX. LAMP WATT:
50W R20, 50W PAR20, 50W BR20

BAFFLE:
W, P

RING:
WH

B673 _____
PAR30 GIMBAL TRIM (35° TILT)

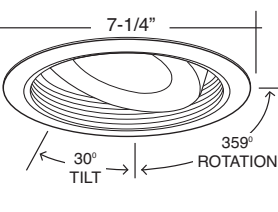

MAX. LAMP WATT:
75W PAR30, 50W PAR30

BAFFLE:
W, P, SN, CP

RING:
WH, BK, SN, CP, CH, PB

GIMBAL RING:
WH, BK, SN, CP, CH, PB

RING/TRIM FINISHES: WH=White BK=Black SN=Satin Nickel CP=Copper CH=Chrome PB=Polished Brass BZ=Bronze
BAFFLE FINISHES: W=White P=Black SN=Satin Nickel CP=Copper BZ=Bronze
REFLECTOR FINISHES: CL=Chrome RG=Gold W=White MB=Black CP=Copper SN=Satin Nickel



AF635

BAFFLE W/ ALBALITE LENS

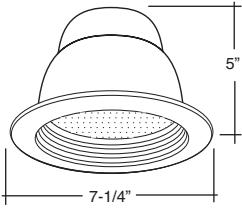

MAX. LAMP WATT:

40W A19

BAFFLE:

W, P, SN, CP

RING:

WH, BK, SN, CP, CH, PB

AF636

BAFFLE W/ FRESNEL LENS

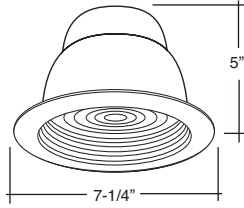

MAX. LAMP WATT:

40W A19

BAFFLE:

W, P, SN, CP

RING:

WH, BK, SN, CP, CH, PB

AF638

BAFFLE W/ DROP OPAL LENS

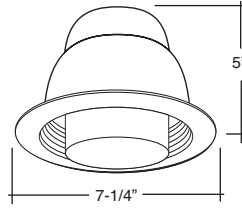

MAX. LAMP WATT:

40W A19

BAFFLE:

W, P, SN, CP

RING:

WH, BK, SN, CP, CH, PB



6"

RING/TRIM FINISHES: WH=White BK=Black SN=Satin Nickel CP=Copper CH=Chrome PB=Polished Brass BZ=Bronze

BAFFLE FINISHES: W=White P=Black SN=Satin Nickel CP=Copper BZ=Bronze

REFLECTOR FINISHES: CL=Chrome RG=Gold W=White MB=Black CP=Copper SN=Satin Nickel

