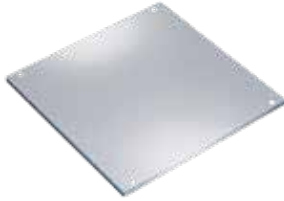
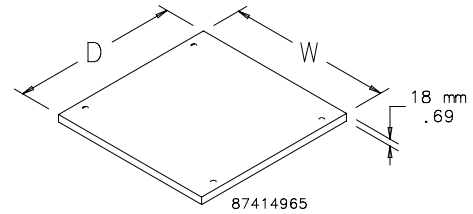

SOLID TOPS

Solid Tops are used to close the top opening on an enclosure frame. Steel Tops are finished in RAL 7035 textured light gray. EMC Solid Tops are finished with paint over plated surfaces. Solid Tops are gasketed and include ground studs. Bolts are included to hold the top in place (lifting eyes can be used instead of bolts). Tops are made of 16-gauge steel.

BULLETIN: P20, P20EM, P20S

Catalog Number	Type	Frame Type	Fits Frame B x C	W (mm)	W (in.)	D (mm)	D (in.)
PT45	Steel	Single-Bay	400 x 500	399	15.71	499	19.65
PT46	Steel	Single-Bay	400 x 600	399	15.71	599	23.58
PT64	Steel	Single-Bay	600 x 400	592	23.31	399	15.71
PT64HF2	EMC	Single-Bay	600 x 400	592	23.31	399	15.71
PT65	Steel	Single-Bay	600 x 500	592	23.31	499	19.65
PT66	Steel	Single-Bay	600 x 600	592	23.31	599	23.58
PT66HF2	EMC	Single-Bay	600 x 600	592	23.31	599	23.58
PT66SS	Stainless Steel	Single-Bay	600 x 600	592	23.31	599	23.58
PT68	Steel	Single-Bay	600 x 800	592	23.31	799	31.46
PT68HF2	EMC	Single-Bay	600 x 800	592	23.31	799	31.46
PT68SS	Stainless Steel	Single-Bay	600 x 800	592	23.31	799	31.46
PT76	Steel	Single-Bay	700 x 600	692	27.24	599	23.58
PT76HF2	EMC	Single-Bay	700 x 600	692	27.24	599	23.58
PT78	Steel	Single-Bay	700 x 800	692	27.24	799	31.46
PT78HF2	EMC	Single-Bay	700 x 800	692	27.24	799	31.46
PT79	Steel	Single-Bay	700 x 900	692	27.24	899	35.39
PT79HF2	EMC	Single-Bay	700 x 900	692	27.24	899	35.39
PT84	Steel	Single-Bay	800 x 400	792	31.18	399	15.71
PT84HF2	EMC	Single-Bay	800 x 400	792	31.18	399	15.71
PT85	Steel	Single-Bay	800 x 500	792	31.18	499	19.65
PT85HF2	EMC	Single-Bay	800 x 500	792	31.18	499	19.65
PT86	Steel	Single-Bay	800 x 600	792	31.18	599	23.58
PT86HF2	EMC	Single-Bay	800 x 600	792	31.18	599	23.58
PT86SS	Stainless Steel	Single-Bay	800 x 600	792	31.18	599	23.58
PT88	Steel	Single-Bay	800 x 800	792	31.18	799	31.46
PT88HF2	EMC	Single-Bay	800 x 800	792	31.18	799	31.46
PT88SS	Stainless Steel	Single-Bay	800 x 800	792	31.18	799	31.46
PT89	Steel	Single-Bay	800 x 900	792	31.18	799	31.46
PT89HF2	EMC	Single-Bay	800 x 900	792	31.18	799	31.46
PT104	Steel	Single-Bay	1000 x 400	992	39.06	399	15.71
PT105	Steel	Single-Bay	1000 x 500	992	39.06	499	19.65
PT105HF2	EMC	Single-Bay	1000 x 500	992	39.06	499	19.65
PT106	Steel	Single-Bay	1000 x 600	992	39.06	599	23.58
PT106SS	Stainless Steel	Single-Bay	1000 x 600	992	39.06	599	23.58
PT106HF2	EMC	Single-Bay	1000 x 600	992	39.06	599	23.58
PT108	Steel	Single-Bay	1000 x 800	992	39.06	799	31.46
PT108HF2	EMC	Single-Bay	1000 x 800	992	39.06	799	31.46
PT108SS	Stainless Steel	Single-Bay	1000 x 800	992	39.06	799	31.46
PT124	Steel	Double-Bay	1200 x 400	1192	46.93	399	15.71
PT125	Steel	Double-Bay	1200 x 500	1192	46.93	499	19.65
PT126	Steel	Double-Bay	1200 x 600	1192	46.93	599	23.58
PT126SS	Stainless Steel	Double-Bay	1200 x 600	1192	46.93	599	23.58
PT128	Steel	Double-Bay	1200 x 800	1192	46.93	799	31.46
PT128SS	Stainless Steel	Double-Bay	1200 x 800	1192	46.93	799	31.46
PT164	Steel	Double-Bay	1600 x 400	1592	62.68	399	15.71
PT165	Steel	Double-Bay	1600 x 500	1592	62.68	499	19.65
PT166	Steel	Double-Bay	1600 x 600	1592	62.68	599	23.58
PT168	Steel	Double-Bay	1600 x 800	1592	62.68	799	31.46
PT185	Steel	Double-Bay	1800 x 500	1792	70.55	499	19.65
PT186	Steel	Double-Bay	1800 x 600	1792	70.55	599	23.58
PT188	Steel	Double-Bay	1800 x 800	1792	70.55	799	31.46

VENTED TOP WITH INTEGRAL FAN TRAY



INDUSTRY STANDARDS

UL Component Recognized; Type 1; File No. E61997
 This component is rated UL Type 1. Installing this component on an enclosure brings the enclosure rating to UL Type 1.

This component is rated UL Type 1. Installing this component on an enclosure brings the enclosure rating to UL Type 1.
 NEMA/EEMAC Type 1
 IEC 60529, IP20

tray with three pre-wired and mounted fans provides up to 200-300 CFM of exhaust.

The deeper vented tops (500- through 800-mm deep) have integral fan trays with cutouts for mounting additional fans (see Additional Fans table). Accessory fan kits (consisting of three pre-wired fans) can be installed to provide additional airflow. Unused fan positions are provided with covers to prevent short-circuiting of airflow. Since the fan pulls air through the enclosure to cool equipment, an optional Inlet Vent (catalog number PPV32 or PPV32B) must be ordered separately. Vented tops are 16-gauge steel and finished with RAL 7035 light-gray textured polyester powder paint. EMC tops are finished with paint over plated 16-gauge surfaces.

The vented top is designed to be used in place of a standard top. Bolts are provided to secure vented top to frame. The enclosure can be lifted with a vented top installed (requires accessory lifting eyes).

BULLETIN: DPC, P20EM

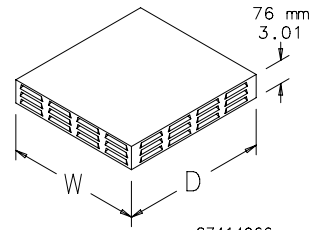

87414966

Vented Top with Integral Fan Tray provides a cooling/ventilation solution for electronic and networking applications. An integral fan

Catalog Number	Type	Voltage	Fits Frame Top B x C	W (mm)	W (in.)	D (mm)	D (in.)
PVT3F641	Steel	115	600 x 400	591	23.26	392	15.46
PVT3F651	Steel	115	600 x 500	592	23.31	493	19.40
PVT3F651EMC	EMC	115	600 x 500	591	23.26	493	19.40
PVT3F661	Steel	115	600 x 600	591	23.26	593	23.33
PVT3F661EMC	EMC	115	600 x 600	591	23.26	593	23.34
PVT3F681	Steel	115	600 x 800	591	23.26	793	31.12
PVT3F681EMC	EMC	115	600 x 800	591	23.26	793	31.21
PVT3F761	Steel	115	700 x 600	691	27.20	593	23.34
PVT3F761EMC	EMC	115	700 x 600	691	27.20	593	23.34
PVT3F781	Steel	115	700 x 800	691	27.20	793	31.21
PVT3F781EMC	EMC	115	700 x 800	691	27.20	793	31.21
PVT3F791	Steel	115	700 x 900	691	27.20	893	35.15
PVT3F791EMC	EMC	115	700 x 900	691	27.20	893	35.15
PVT3F841	Steel	115	800 x 400	791	31.13	393	15.46
PVT3F851	Steel	115	800 x 500	792	31.18	493	19.40
PVT3F851EMC	EMC	115	800 x 500	791	31.13	493	19.40
PVT3F861	Steel	115	800 x 600	792	31.18	593	23.34
PVT3F861EMC	EMC	115	800 x 600	791	31.13	593	23.34
PVT3F881	Steel	115	800 x 800	792	31.18	793	31.21
PVT3F881EMC	EMC	115	800 x 800	791	31.13	793	31.21
PVT3F642	Steel	230	600 x 400	591	23.26	393	15.46
PVT3F652	Steel	230	600 x 500	591	23.26	493	19.40
PVT3F652EMC	EMC	230	600 x 500	591	23.26	493	19.40
PVT3F662	Steel	230	600 x 600	591	23.26	593	23.34
PVT3F662EMC	EMC	230	600 x 600	591	23.26	593	23.34
PVT3F682	Steel	230	600 x 800	591	23.26	793	31.21
PVT3F682EMC	EMC	230	600 x 800	591	23.26	793	31.21
PVT3F762	Steel	230	700 x 600	691	27.20	593	23.34
PVT3F762EMC	EMC	230	700 x 600	691	27.20	593	23.34
PVT3F782	Steel	230	700 x 800	691	27.20	793	31.21
PVT3F782EMC	EMC	230	700 x 800	691	27.20	793	31.21
PVT3F792	Steel	230	700 x 900	691	27.20	893	35.15
PVT3F792EMC	EMC	230	700 x 900	691	27.20	893	35.15
PVT3F842	Steel	230	800 x 400	791	31.13	393	15.46
PVT3F852	Steel	230	800 x 500	791	31.13	493	19.40
PVT3F852EMC	EMC	230	800 x 500	791	31.13	493	19.40
PVT3F862	Steel	230	800 x 600	791	31.13	593	23.34
PVT3F862EMC	EMC	230	800 x 600	791	31.13	593	23.34
PVT3F882	Steel	230	800 x 800	791	31.13	793	31.21
PVT3F882EMC	EMC	230	800 x 800	791	31.13	793	31.21

Additional Fans

Catalog Number	Voltage	Description
PVT3F1	115	3-fan kit
PVT3F2	230	3-fan kit

Number of Fans for Frame Depth

Frame Depth	Number of Fans Provided	Maximum Number of Fans Possible
400	3	3
500	3	6
600	3	6
800	3	9
900	3	9

Individual Fan Performance

Fan Performance	50 Hz	60 Hz
Airflow @ in. static pressure	95 CFM (162 cu. m/hr)	113 CFM (192 cu. m/hr)
Maximum static pressure W.C.	0.29 in. (73 Pa)	0.35 in. (98 Pa)
Maximum ambient temp	158 F (70 C)	158 F (70 C)
Power consumption	15 W	14 W

PAGODA TOPS

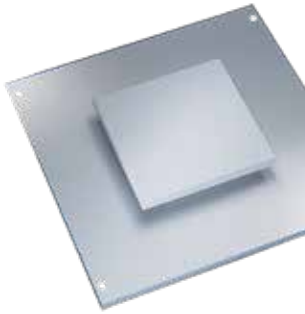

Pagoda Tops are available to fit on standard frames. Design features a drip-proof raised pagoda vent with a 115-volt integral axial exhaust fan. Double-bay Pagoda Tops have one drip-proof raised pagoda vent opening positioned over one bay that can be oriented for right or left ventilation. Pagoda Tops are finished with RAL 7035 textured light-gray polyester powder paint. Bolts secure pagoda top to frame (lifting eyes can be used instead of bolts).

BULLETIN: P20

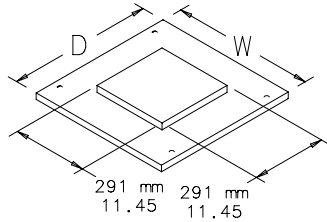

87417326

Catalog Number	Gauge	Frame Type	Fits Frame Top B x C	W mm/in.	D mm/in.
PPT64	16	Single-Bay	600 x 400	592 23.30	399 15.70
PPT65	16	Single-Bay	600 x 500	592 23.30	499 19.64
PPT66	16	Single-Bay	600 x 600	592 23.30	599 23.57
PPT68	16	Single-Bay	600 x 800	592 23.30	799 31.45
PPT76	16	Single-Bay	700 x 600	692 27.24	599 23.57
PPT78	16	Single-Bay	700 x 800	692 27.24	799 31.45
PPT79	14	Single-Bay	700 x 900	692 27.24	899 35.39
PPT84	16	Single-Bay	800 x 400	592 23.30	399 15.70
PPT85	16	Single-Bay	800 x 500	792 31.17	499 19.64
PPT86	16	Single-Bay	800 x 600	792 31.17	599 23.57
PPT88	14	Single-Bay	800 x 800	792 31.17	799 31.45
PPT89	14	Single-Bay	800 x 900	792 31.17	899 35.39
PPT105	16	Single-Bay	1000 x 500	992 39.05	499 19.64
PPT106	16	Single-Bay	1000 x 600	992 39.05	599 23.57
PPT108	14	Single-Bay	1000 x 800	992 39.05	799 31.45
PPT125	16	Double-Bay	1200 x 500	1192 46.92	499 19.64
PPT126	16	Double-Bay	1200 x 600	1192 46.92	599 23.57
PPT128	14	Double-Bay	1200 x 800	1192 46.92	799 31.45
PPT165	16	Double-Bay	1600 x 500	1592 62.67	499 19.64
PPT166	16	Double-Bay	1600 x 600	1592 62.67	599 23.57
PPT168	14	Double-Bay	1600 x 800	1592 62.67	799 31.45

PAGODA EXHAUST VENTS



Pagoda Exhaust Vents can be field-installed on any PROLINE solid top. An axial fan and finger guard are mounted in a housing. A drip-proof raised cover is removable from inside the enclosure. Gasket and mounting hardware are included. Vent housing and raised cover are 14 gauge steel finished with RAL 7035 textured light-gray polyester powder paint.

BULLETIN: DTHRM, P20

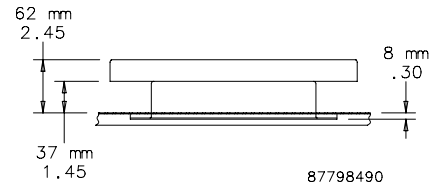
Catalog Number	Description	Volts
PPT1	Leadwires	115
PPT1C	Power cord	115
PPT2	Leadwires	230

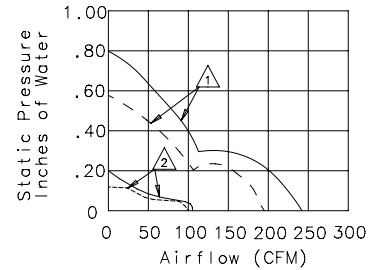

87798490

Performance Curve: 6 in. Fans

(Curves represent fan performance only.)

FNPG, FN, FN2 models ——— 60 Hz
 FNGQ models - - - - - 50 Hz

87924791

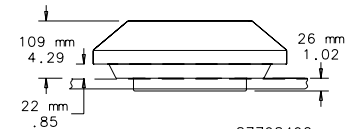
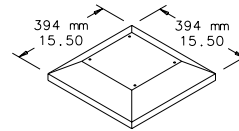
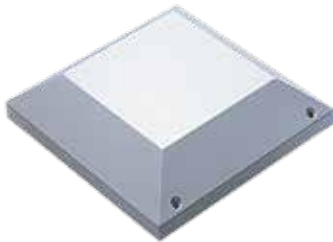
HIGH-PERFORMANCE PAGODA EXHAUST VENT

87798492

Vents fit on standard PROLINE top with vent cutout or can be field-installed on any PROLINE solid top. The Pagoda Vent features an integral centrifugal blower mounted in a housing that includes a drip-proof removable hood, wire mesh finger guard, perimeter gasket and terminal block. Electromagnetic-compatible (EMC) Pagoda Vents include a conductive screen, conductive gasket, line filter and 6-ft. power cord with stripped leads. Pagoda Vent housing and hood are rugged 16 gauge steel finished with RAL 7035 textured light-gray polyester powder paint. EMC vents are finished with paint over plated surfaces. Installation hardware is included.

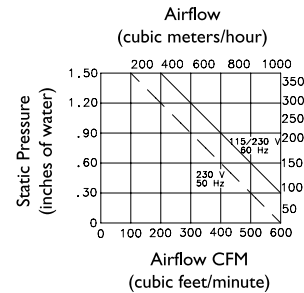
BULLETIN: DTHRM, P20, P20EM

87798491

Catalog Number	Description	Voltage	Full Load Amps	Use With
PPTH1	Leadwires	115	1.7	Top with high-performance pagoda vent cutout
PPTH1C	Power cord	115	1.7	Top with high-performance pagoda vent cutout
PPTH1EMC	Power cord	115	1.7	Top with high-performance pagoda vent cutout on EMC enclosures
PPTH2	Leadwires	230	.9	Top with high-performance pagoda vent cutout
PPTH2EMC	Power cord	230	.9	Top with high-performance pagoda vent cutout

TOP WITH CUTOUT FOR HIGH-PERFORMANCE PAGODA EXHAUST VENT



The tops fit standard frames. Single-bay tops have a cutout that accepts one high-performance pagoda vent. Double-bay tops have one cutout that can be oriented for left-bay or right-bay pagoda

ventilation. Tops are finished with textured light-gray RAL 7035 polyester powder paint. EMC tops are finished with paint over plated surfaces. Bolts are furnished to hold top in position (lifting eyes can be used in place of bolts). Top is gasketed and made of 16-gauge steel. Ground studs are included. Consult Hoffman for delivery.

BULLETIN: P20, P20EM

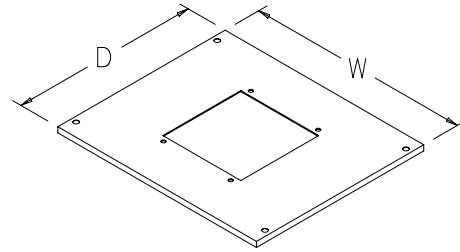

87417327

Catalog Number	Fits Frame Top B x C	W (mm)	W (in.)	D (mm)	D (in.)
PPTHP65	600 x 500	592	23.30	499	19.64
PPTHP65EMC	600 x 500	592	23.30	499	19.64
PPTHP66	600 x 600	592	23.30	599	23.57
PPTHP66EMC	600 x 600	592	23.30	599	23.57
PPTHP68	600 x 800	592	23.30	799	31.45
PPTHP76	700 x 600	692	27.24	599	23.57
PPTHP76EMC	700 x 600	692	27.24	599	23.57
PPTHP78EMC	700 x 800	692	27.24	799	31.45
PPTHP79	700 x 900	692	27.24	899	35.39
PPTHP79EMC	700 x 900	692	27.24	899	35.39
PPTHP85	800 x 500	792	31.17	499	19.64
PPTHP85EMC	800 x 500	792	31.17	499	19.64
PPTHP86	800 x 600	792	31.17	599	23.57
PPTHP86EMC	800 x 600	792	31.17	599	23.57
PPTHP88	800 x 800	792	31.17	799	31.45
PPTHP88EMC	800 x 800	792	31.17	799	31.45
PPTHP89EMC	800 x 900	792	31.17	899	35.39
PPTHP105	1000 x 500	992	39.05	499	19.64
PPTHP105EMC	1000 x 500	992	39.05	499	19.64
PPTHP106	1000 x 600	992	39.05	599	23.57
PPTHP106EMC	1000 x 600	992	39.05	599	23.57
PPTHP108	1000 x 800	992	39.05	799	31.45
PPTHP108EMC	1000 x 800	992	39.05	799	31.45
PPTHP125EMC	1200 x 500	1192	46.95	499	19.64
PPTHP126	1200 x 600	1192	46.92	599	23.57
PPTHP126EMC	1200 x 600	1192	46.92	599	23.57
PPTHP128	1200 x 800	1192	46.92	799	31.45
PPTHP128EMC	1200 x 800	1192	46.92	799	31.45
PPTHP165	1600 x 500	1192	62.67	499	19.64
PPTHP165EMC	1600 x 500	1592	62.67	499	19.64
PPTHP166	1600 x 600	1592	62.67	599	23.57
PPTHP166EMC	1600 x 600	1592	62.67	599	23.57
PPTHP168	1600 x 800	1592	62.67	799	31.45
PPTHP168EMC	1600 x 800	1592	62.67	799	31.45

TOP-MOUNT AIR CONDITIONER

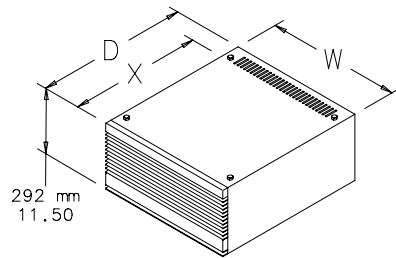

87414969

Top-Mount Air Conditioners replace the solid top in a standard assembly. Air conditioners require no hole cutting or special kits for installation. These air conditioners are available with cooling capacities of 2200 and 4000 BTU/hr. and are equipped with an adjustable thermostat for optimal enclosure temperature regulation. Top-Mount Air Conditioners are finished with RAL 7035 textured light-gray polyester powder paint.

Installing this air conditioner on an enclosure maintains the Type 12 rating.

1. Gasket kit and hardware for mounting to enclosure are included.
2. Condensate overflow drain hose included.

BULLETIN: PAC

Catalog Number	W x D mm/in.	Fits Frame Top B x C	X mm/in.	FLA @ Max. Amb. Temp.	FLA @ Max. Amb. Temp.	FLA @ Max. Amb. Temp.	FLA @ Max. Amb. Temp.	BTU/Hr. (W) @ Max. Amb. Temp.	BTU/Hr. (W) @ Max. Amb. Temp.	BTU/Hr. (W) @ Max. Amb. Temp.	BTU/Hr. (W) @ Max. Amb. Temp.	Max. Amb. Temp. °F	Max. Amb. Temp. °C	Ship Wt. (lb.)	Ship Wt. (kg)
PAC216T66	592 x 600 23.31 x 23.62	600 x 600	514 20.25	115/60 6.8	115/50 6.8	230/60 —	230/50 —	2200 (702) 115/60	2200 (644) 115/50	— 230/60	— 230/50	125	52	140	64
PAC226T86	792 x 600 31.19 x 23.62	800 x 600	376 14.80	—	—	4.2	4.3	—	—	2400 (703)	2100 (615)	125	52	180	82

DOUBLE-BAY AIR CONDITIONER TOP

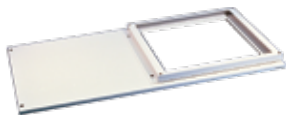

Top provides mounting accommodations for PROLINE Top Mount Air Conditioners. Top can rotate for either left-side or right-side mounting for double bay frames. Finish is RAL 7035 light-gray polyester powder paint. Top cover, support bracket and mounting hardware are included in each package.

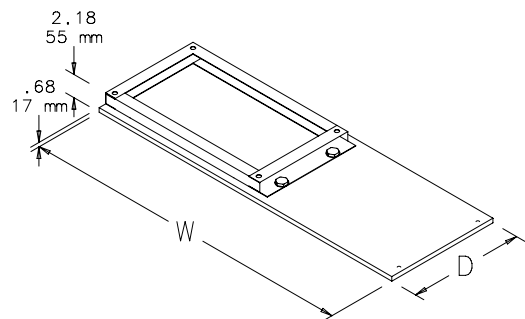
BULLETIN: PAC

87575760

Catalog Number	Fits Frame Top B x C	Gauge	W mm/in.	D mm/in.	Fits Top Mount Air Conditioners
PTAC126	1200 x 600	16	1192 46.93	599 23.58	PAC216T66, PAC226T66, PAC416T66, PAC426T66
PTAC128	1200 x 800	14	1192 46.93	799 31.46	PAC416T68, PAC426T68
PTAC166	1600 x 600	16	1592 62.68	599 23.58	PAC216T86, PAC226T86, PAC416T86, PAC426T86
PTAC168	1600 x 800	14	1592 62.68	799 31.46	PAC416T88, PAC426T88

SUPPORT BRACKET KIT

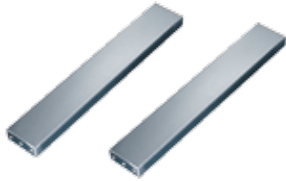

Brackets provide additional support for large air conditioners or other heavy devices that can be mounted on modular enclosure sides. Support brackets fit between the frame and sides to provide two horizontal rigid supports. They can be positioned at various heights to accommodate any size air conditioner or device. Brackets can also be used between frames and tops for supporting heavy devices mounted on top of modular enclosures. Brackets are plated 14 gauge steel and are furnished in pairs. Hardware for mounting brackets is included.

BULLETIN: P20

Catalog Number	Fits Frame Size
PACB4	400-mm deep frames
PACB5	500-mm deep frames
PACB6	600-mm deep frames
PACB8	800-mm deep frames

SPECTRACOOL SLIM FIT INDOOR AIR CONDITIONER



SPECTRACOOL Slim Fit Air Conditioners are great for industrial applications rated UL Listed Type 12. These versatile coolers can be mounted in three depths, full surface mounts, partial mount, and fully recessed. Performance ranging from 1000 BTU/hr to 13,500 BTU/hr make these air conditioners perfect for any indoor industrial application. For more detail product information, visit www.pentairprotect.com or reference the Hoffman Cooling Specifier's Guide.

Description	115 Volt	230 Volt	400/460 Volt 3-Phase
1000 BTU/hr. / 300 Watts	S060316G050	S060326G050	—
1700 BTU/hr. / 500 Watts	S060516G050	S060526G050	—
3400 BTU/hr. / 500 Watts	S101016G050	S101026G050	S101046G050
5000 BTU/hr. / 1500 Watts	S101516G050	S101526G050	S101546G050
6800 BTU/hr. / 2000 Watts	S162016G050	S162026G050	S162046G050
8500 BTU/hr. / 2500 Watts	S162516G050	S162526G050	S162546G050
13500 BTU/hr. / 4000 Watts	—	—	S164046G050