

SLATER® PLASTIC BOXES

Low-Voltage Brackets

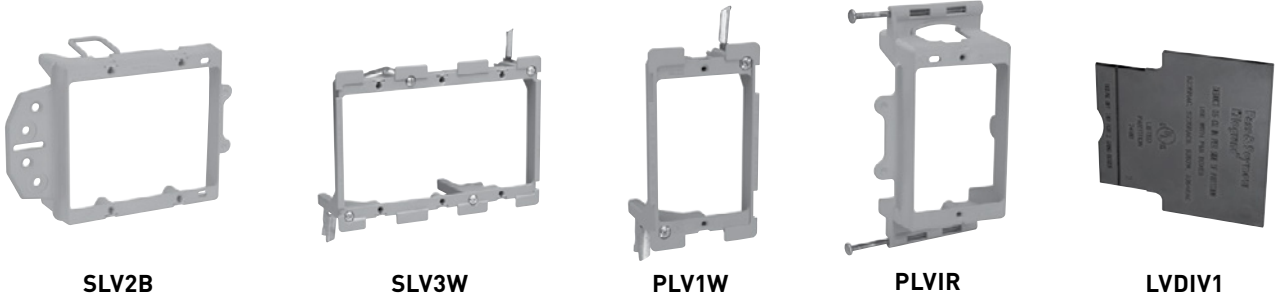

CATALOG NUMBER	CU. IN. VOL.	DESCRIPTION	DIMENSIONS			WIRE FILL (AWG)	QTY. PER CARTON
			L	W	D		
LOW-VOLTAGE BRACKETS WITH QUICK/CLICK® for class 2 low-voltage applications							
SDV2B	22.5	Two gang. For dual-voltage. Face mount box and bracket for new construction.	3¾	4	3¾	11 No. 14 10 No. 12 9 No. 10	12
SLV1R	-	Single gang. Nail on for new construction.	3¾	2¼	-	-	12
SLV1S	-	Single gang. Nail on for new construction.	3¾	2¼	-	-	12
SLV1B	-	Single gang. Face mount bracket for new construction.	3¾	2¼	-	-	12
SLV2B	-	Two gang. Face mount bracket for new construction.	3¾	4	-	-	12
SLV1W	-	Single gang. Swing bracket mount for old work.	3¾	2¼	-	-	12
SLV2W	-	Two gang. Swing bracket mount for old work.	3¾	4	-	-	12
SLV3W	-	Three gang. Swing bracket mount for old work.	3¾	6	-	-	12
LOW-VOLTAGE BRACKETS for class 2 low-voltage applications							
P100WD	8.0	Single Gang. Gangable. Swing bracket for mounting, adjusts from 1¼" down to 1/8", for old work, stand alone applications.	3¾	2	-	-	15
P100ND	8.0	Single gang. With vertical side bracket for new construction, with wire retaining fingers.	3¾	2¾	1¼	-	15
PDV2B	22.5	Two gang. For dual-voltage. Face mount box and bracket for new construction.	3¾	4	3¾	11 No. 14 10 No. 12 9 No. 10	12
PLV1R	-	Single gang. Nail on for new construction.	3¾	2¼	-	-	12
PLV1S	-	Single gang. Screw on for new construction.	3¾	2¼	-	-	12
PLV1B	-	Single gang. Face mount bracket for new construction.	3¾	2¼	-	-	12
PLV2B	-	Two gang. Face mount bracket for new construction.	3¾	4	-	-	12
PLV1W	-	Single gang. Swing bracket mount for old work.	3¾	2¼	-	-	12
PLV2W	-	Two gang. Swing bracket mount for old work.	3¾	4	-	-	12
PLV3W	-	Three gang. Swing bracket mount for old work.	3¾	6	-	-	12
DIVIDER PLATE							
LVDIV1	-.5	Suitable for low-voltage or multiple 277V devices. For use with S235RAC, S235RACS, P235RAC, S235S50AC, S354RAC and S352W.	-	-	-	-	12

All boxes are UL listed.

SLATER® PLASTIC BOXES

Applications & Product Features

Application

Slater Plastic Boxes, the Contractor's Choice designed with unique labor-saving features, include a complete range of wall, ceiling, and old work boxes for commercial and residential construction applications.

UL Classified

All Slater Plastic Boxes are Underwriters Laboratories Listed. Slater Plastic Boxes shown that are UL Classified for Fire Resistance meet the requirements of UL263 and have a two hour fire resistance rating. These boxes may be used in fire resistant walls and ceilings. Installation information for Slater Plastic Boxes Classified for Fire Resistance may be found in the UL Fire Resistance Directory under category CEYY for Legrand.



Product Features – Exclusive Auto/Clamp®

Eliminates the need for separate cable clamps as well as the tools usually needed for installation.

Auto/Clamp® is available on all multigang boxes, old work boxes, 4" square boxes, and 3-1/4" and 4" round ceiling boxes. A major installation advantage with Auto/Clamp® is that the clamp is molded as an integral part of the box (there are no separate clamps and screws to install, adjust or tighten). Each cable opening contains an Auto/Clamp®, therefore, the non-metallic sheathed cable may be inserted where needed or where most convenient. Auto/Clamp® does not take up as much room as conventional clamps, allowing more room for wire and devices – another important feature.

To install the cable, insert stripped or unstripped non-metallic wire into the Auto/Clamp® opening and pull through to the desired length. The cable is automatically secured and the installation is complete. There are no other operations for the electrician to perform. Contractors can look forward to saving time and money with every Auto/Clamp® plastic box installation.

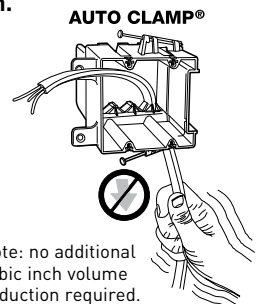

Location Ribs

Location Ribs enable the installer to quickly and accurately maintain a 1/2" offset. Dual ribs also make it easy to keep the face of the box parallel to the stud. The ribs are .450" long to reduce the chance of the box protruding beyond the 1/2" sheetrock. They project .080" to span the rounded edges of wood studs but will not cause excessive canting of the box when used with thinner wallboard.

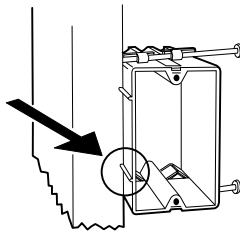

Quick/Entry®

Speeds installation by eliminating need for tools

Another time-saving idea is Quick/Entry®, a method that allows you to push stripped or unstripped non-metallic cable into a single gang plastic box without removing knock-outs. Jagged edges usually formed in other boxes are eliminated. Staple wire to stud within 8" of the box [per NEC 314.17(c)] to complete installation.

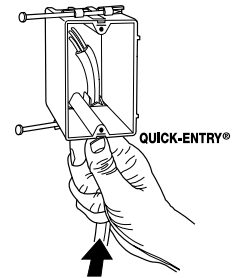

Quick/Click®

Fast, easy, and secure installations.

The unique, labor-saving Quick/Click® design secures the wiring device quickly and easily. Simply push in the mounting screws with a screwdriver and turn the screw one turn.

With Quick/Click® you cannot cross-thread or strip a device mounting screw.

Wall boxes are tested for a minimum 100 lb. total device pull-out resistance.

How Quick/Click® Works

The **spring steel** insert for quick mounting of switches and receptacles is a unique patented feature. (Refer to illustration.) Note how the spring acts as a locking ratchet and allows the screw to be pushed in and then tightened. The screw can only be released by unscrewing it in the conventional fashion.

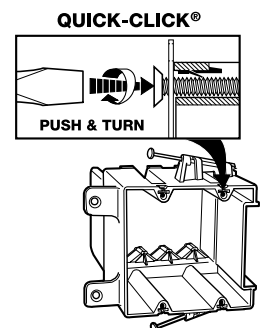
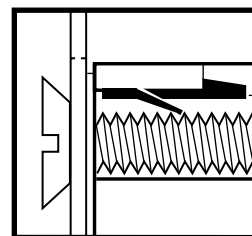

SLATER® PLASTIC BOXES

Applications & Product Features

Wood & Steel Stud Bracket Boxes – Application

Single, two, three, four gang and 4" square wood and steel stud boxes feature Quick/Click®, the labor-saving device that assures quick and dependable installation of switches and receptacles. These high-impact thermoplastic boxes can be mounted quickly to steel or aluminum studs using the CT-1 Crimping Tool. They can also be mounted to wooden studs with common nails or screws.

On the single, two, three and four gang steel stud boxes, a steel mounting bracket is provided for mounting to the structural stud. The non-mounting side of the two and four gang box has provisions for attachment to a short section of stud (phantom stud), as shown in the illustration below, to give additional rigidity to the installation. This assembly may also be used without the phantom stud as a positioning tab to automatically realign the box to the wallboard surface. The brackets are 3/8" offset to accommodate 3/8" to 5/8" thick wallboard.



Features

- Available in single, two, three, four gang and 4" square boxes. Two, three and four gang boxes and 4" square include exclusive Auto/Clamp® feature.
- Single gang include Quick/Entry® feature.
- Quick/Click® feature offers fast and dependable installation of devices (single, two, three and four gang).
- Unique offset tab assures proper alignment to wall face. Available with 3/8" offsets.
- Can be used for steel, aluminum, or wooden studs. Can be installed on steel studs with most standard crimping tools in addition to CT-1 Crimping Tool.
- Molded of high-impact thermoplastic.

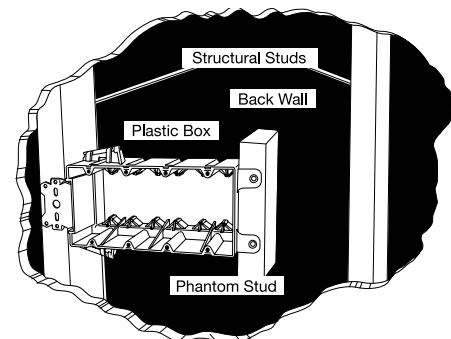

Screw Mount: Steel Stud Boxes – Application

Single, deep single, two, three, four gang, and 4" round ceiling boxes come with combination Hex/Phillips washer head screws. They are designed to save labor and speed installation in steel stud construction. These innovative boxes are an alternative to bracket boxes, and can also be used on wood studs. The specially designed drill point on the screw rapidly penetrates medium gauge steel studs to securely fasten the box. Locator ribs 0.450" long help align the box on the stud and insure correct mounting depth.

Features

- Available in single, single deep, two, three and four gang, and 4" round ceiling boxes.
- All multi-gang and ceiling boxes include exclusive Auto/Clamp® feature.
- Single gang include Quick/Entry® feature.
- Specially designed drill point rapidly penetrates medium gauge steel studs.
- Screws have combination Hex/Phillips washer heads.
- Quick/Click® feature on wall boxes offers fast and dependable installation of devices.
- Can be used for steel, aluminum, or wood studs.
- Molded of high-impact thermoplastic.
- Locator ribs ensure proper alignment on stud and proper offset depth.

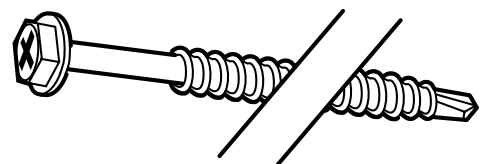

SLATER® PLASTIC BOXES

Applications & Product Features

Old Work Boxes

Application

Old Work Boxes provide fast, easy installation of an electrical device in a finished (dry walled) area where no box existed before. Old Work Boxes include the Auto/Clamp® and Quick/Click® features for convenient, labor-saving installations.

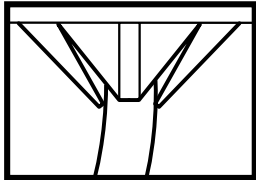

Box Volume Required

TOTAL CONDUCTOR FILL COUNT	CUBIC INCHES REQUIRED FOR		
	#14 WIRE	#12 WIRE	#10 WIRE
1	2.0	2.25	2.50
2	4.0	4.50	5.00
3	6.0	6.75	7.50
4	8.0	9.00	10.00
5	10.0	11.25	12.50
6	12.0	13.50	15.00
7	14.0	15.75	17.50
8	16.0	18.00	20.00
9	18.0	20.25	22.50
10	20.0	22.50	25.00
11	22.0	24.75	27.50
12	24.0	27.00	30.00
13	26.0	29.25	32.50
14	28.0	31.50	35.00
15	30.0	33.75	37.50
16	32.0	36.00	40.00
17	34.0	38.25	42.50
18	36.0	40.50	45.00
19	38.0	42.75	47.50
20	40.0	45.00	50.00

In addition to counting 1 conductor fill allowance for each conductor, 1 additional allowance must be counted for all cable clamps, and 1 additional allowance for all ground conductors. 2 additional fill allowances must be counted for each device strap. See NEC Section 314.16(b). The table above defines box volume required for resulting total conductor fill count, depending on AWG used.

Features

- Box designed so mounting strap of the device, with plaster ears removed, fits flush, allowing use of standard depth wall plate without unsightly gap between plate and wall surface.
- Swing out wing brackets permit installation of box in wall with 1-1/4" thick wallboard down to 1/8" thick paneling.
- New longer swing brackets have greater reach to clamp onto oversized cutouts.
- Made of high impact thermoplastic.
- Combination slotted/Phillips head swing bracket screws.
- Include exclusive Auto/Clamp® feature.
- Wall boxes include exclusive Quick/Click® feature.
- Available in ceiling box versions.

Standard Mounting Dimensions for Boxes

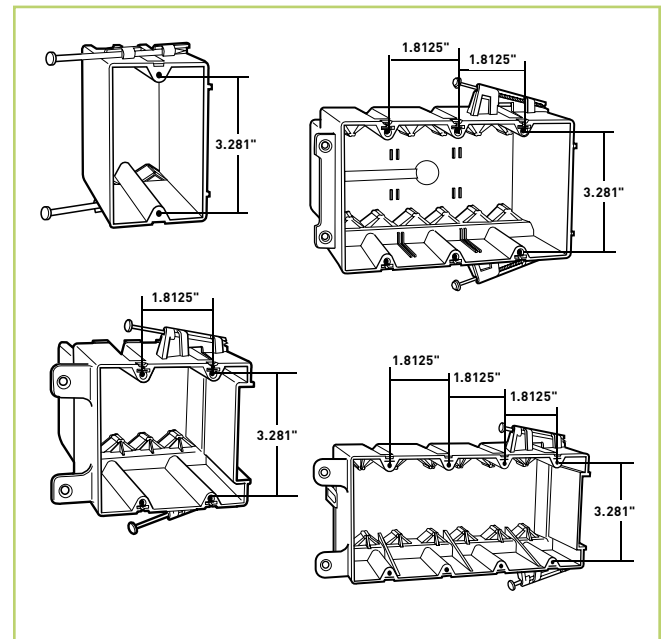

Standard Mounting Dimensions Round Boxes

