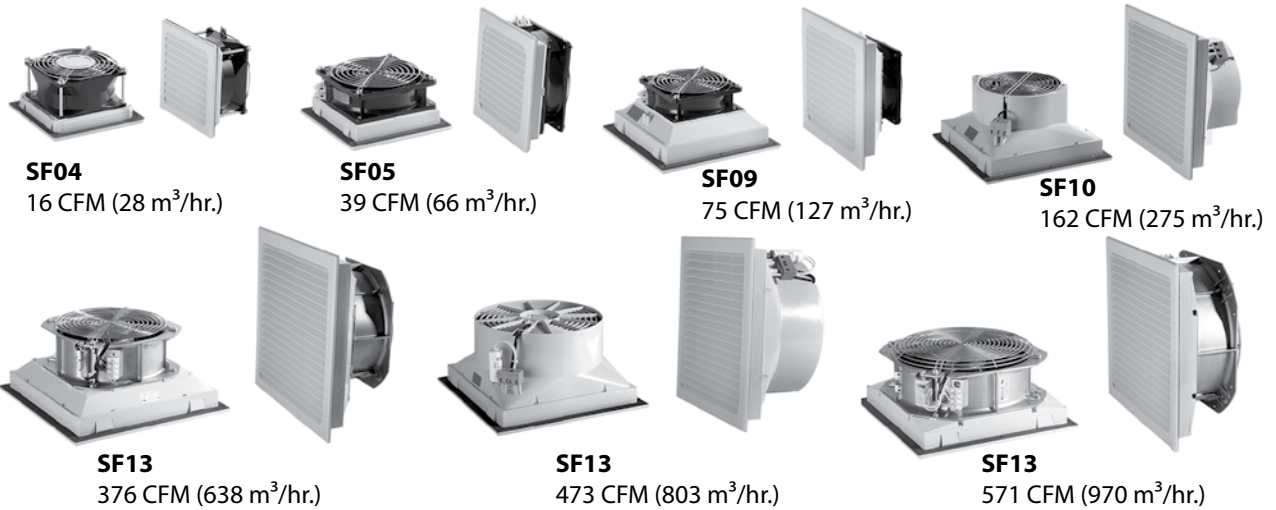

SF SIDE-MOUNT

INDUSTRY STANDARDS

UL/cUL recognized; File No. 235470

CE, CSA (fan motor only)
 Type 12, IP54 standard
 Type 12, IP 55 optional

APPLICATION

- Industrial automation
- Automotive assembly
- Package handling equipment
- Food and beverage process controls
- Wind energy systems

FEATURES

- Click-fit design quickly installs into enclosure wall; no tools or screws required
- Simple snap-open grille for easy filter replacement
- Enclosure side wall mounting
- Reverse airflow option on SF13 models available to push/pull air through higher static pressure
- Standard foam-in-place gasket
- Similar cut-out sizes as other filter fan manufacturers
- Terminal wire connections
- Optional thermostat available to save energy and extend service life

SPECIFICATIONS

- Size range from 4 in. (102 mm) to 13 in. (325 mm)
- Free air flow from 16 CFM (28 m³/hr.) to 571 CFM (920 m³/hr.)
- Service life hours from 40000 to 70000 hours
- Operating temperature range from -4 F/-20 C to 149 F/65 C

FINISH

- RAL 7035 light-gray, UV-resistant plastic standard
- RAL 9011 black, UV-resistant plastic optional

ACCESSORIES

- Replacement filters
- Thermostat
- Rain shroud

NOTES

Visit www.HoffmanOnline.com to download 2D and 3D CAD drawings into the overall design of your electronic system.

Performance Data SF13 376 CFM (638 m³/hr.) Side-Mount Filter Fan - Standard and Reverse

ELECTRICAL DATA						
Rated Voltage	115	230	24	48	115 Rvrs	230 Rvrs
Frequency (Hz)	50 / 60	50 / 60	—	—	50 / 60	50 / 60
Nominal Current Maximum (Amps)	.58 / .70	.29 / .35	2.60	1.30	.58 / .70	.29 / .35
Power Consumption Maximum (Watts)	64 / 80	64 / 80	55	55	64 / 80	64 / 80
Power Connection	Terminal Block					
TYPE 12 / IP54 FILTER FANS						
RAL 7035 Light Gray:						
Catalog Number	SF1316414	SF1326414	SF1324414	SF1348414	SF1316414R	SF1326414R
RAL 9011 Black:						
Catalog Number	SF1316413	SF1326413	SF1324413	SF1348413	SF1316413R	SF1326413R
Free Airflow (CFM / m ³ /hr.)	375 / 638	375 / 638	375 / 638	375 / 638	375 / 638	375 / 638
Airflow with 1 Exhaust Grille (CFM / m ³ /hr.)	249 / 423	249 / 423	249 / 423	249 / 423	249 / 423	249 / 423
Airflow with 2 Exhaust Grilles (CFM / m ³ /hr.)	333 / 565	333 / 565	333 / 565	333 / 565	333 / 565	333 / 565
TYPE 12 / IP55 FILTER FANS						
RAL 7035 Light Gray:						
Catalog Number	SF1316514	SF1326514	SF1324514	SF1348514	—	—
RAL 9011 Black:						
Catalog Number	SF1316513	SF1326513	SF1324513	SF1348513	—	—
Free Airflow (CFM / m ³ /hr.)	346 / 587	346 / 587	346 / 587	346 / 587	—	—
Airflow with 1 Exhaust Grille (CFM / m ³ /hr.)	228 / 387	228 / 387	228 / 387	228 / 387	—	—
Airflow with 2 Exhaust Grilles (CFM / m ³ /hr.)	301 / 511	301 / 511	301 / 511	301 / 511	—	—
FILTER FAN UNIT CONSTRUCTION						
Fan RPM	2550 / 2800	2550 / 2800	2950	2950	2550 / 2800	2550 / 2800
Sound Pressure (dBA)	60	60	60	60	60	60
Operating Temperature Range:						
Maximum (°F / °C)	131 / 55	131 / 55	140 / 60	140 / 60	131 / 55	131 / 55
Minimum (°F / °C)	14 / -10	14 / -10	-13 / -25	-13 / -25	14 / -10	14 / -10
Service Life (hours)	40,000	40,000	40,000	40,000	40,000	40,000
Unit Dimensions - H x W x D (in. / mm)	12.72 x 12.72 x 5.83 / 323 x 323 x 148					
Cutout Dimensions - H x W (in. / mm)	11.5 x 11.5 / 292 x 292					
Weight (lb. / kg)	7.5 / 3.4					
TYPE 12 / IP54 EXHAUST GRILLES						
RAL 7035 Light Gray:						
Catalog Number	SG1300404					
RAL 9011 Black:						
Catalog Number	SG1300403					
TYPE 12 / IP55 EXHAUST GRILLES						
RAL 7035 Light Gray:						
Catalog Number	SG1300504					
RAL 9011 Black:						
Catalog Number	SG1300503					
ACCESSORIES						
Replacement Filters:						
Type 12 / IP54 Catalog Number	10100063					
Type 12 / IP55 Catalog Number	10100067H					
Thermostat Catalog Number	TWR60					
Stainless Steel Washdown Shroud Catalog Number	SH1300005					

Above airflow rates at 60 Hz; see performance curves for airflow at 50 Hz and more details.

Unit depth is from the back edge of the grille to the back of the fan.

Exhaust Grilles sold separately.

SF13 376 CFM (638 m³/hr.) Side-Mount Filter Fan Performance Curve

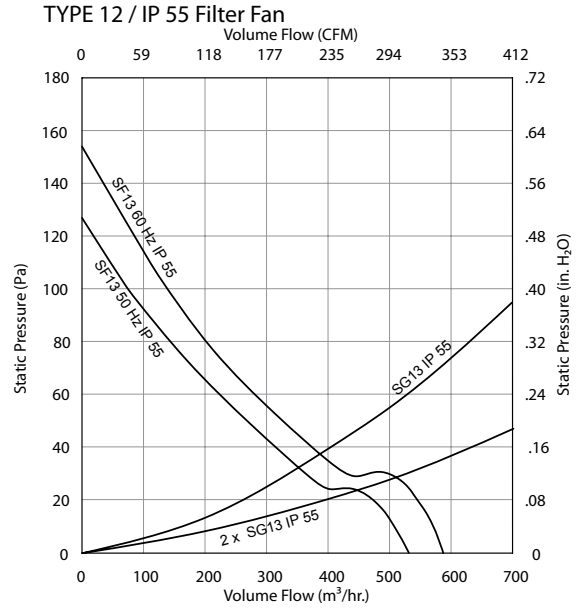
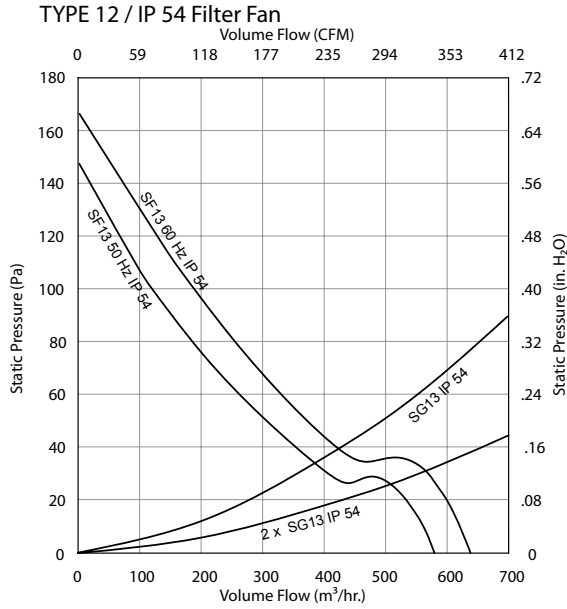

Filter Fan SF13 376 CFM (638 m³/hr.)

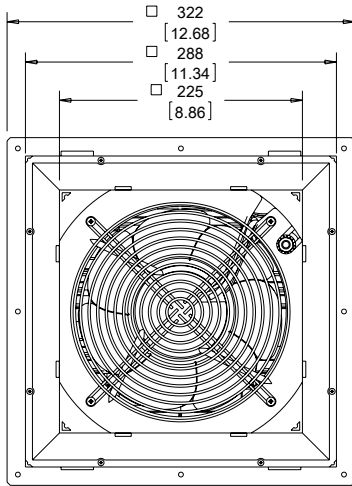

BACK VIEW

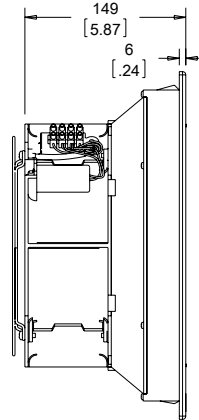

SIDE VIEW

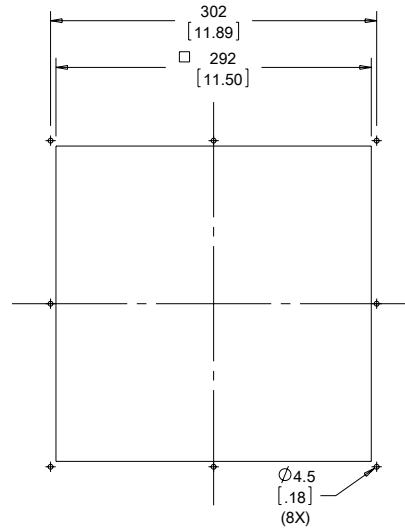

CUTOUT DIMENSIONS

EXHAUST GRILLE

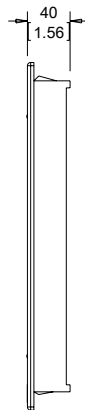
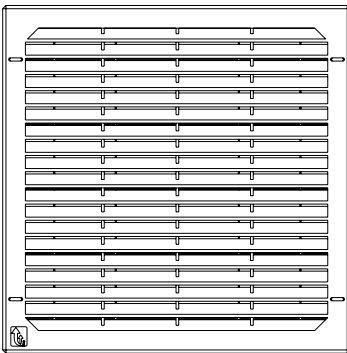

89051221

Order Exhaust Grille Kit separately

Visit www.HoffmanOnline.com to download 2D and 3D CAD drawings into the overall design of your electronic system.