



Non-reversing motor starter
NEMA controller size 2
3-Phase, 3-Pole
Maximum voltage rating 600VAC
Max Hp 60Hz: 10@200V; 15@230V; 25@460V; 25@575V
Solid-state overload relay(s) with 13–52A range
Control voltage 110–120/220–240VAC 60Hz
Open device (no enclosure)

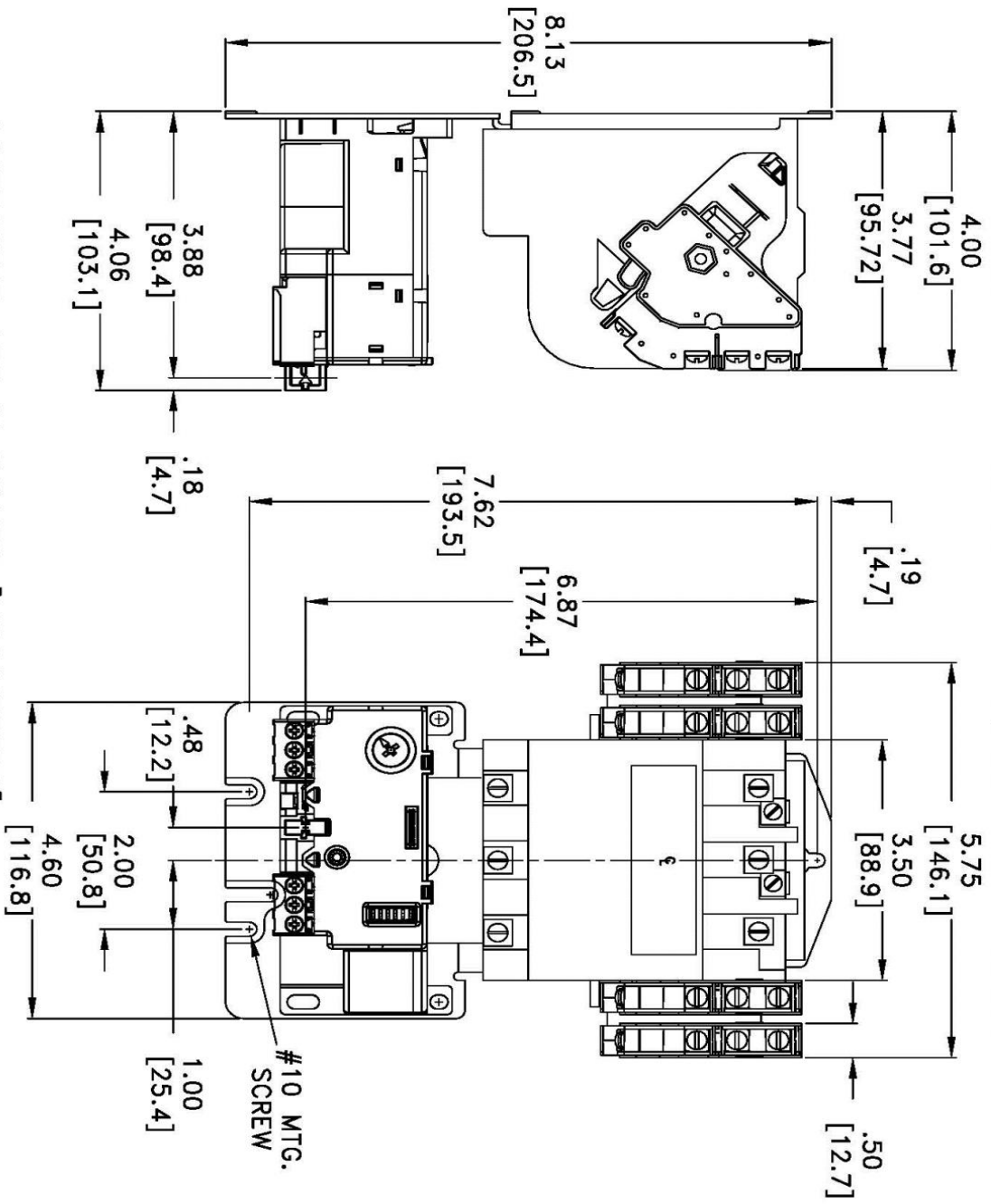

Image is representative and may not depict the actual product.

General technical data:	
Weight	4.5 lb
Height x Width x Depth	8.13 x 5.75 x 4.00 in.
Finger-safe (main circuit / control circuit)	No / No
Maximum altitude	6560 ft
Ambient storage temperature	(-30 to 65)°C / (-22 to 149)°F
Ambient operating temperature	(-20 to 40)°C / (-4 to 104)°F
Humidity (% non-condensing)	(no data)
Rated impulse voltage resistance	(no data)
Rated insulation voltage	(no data)
Country of origin	Mexico
Contactors:	
Number of NO main contacts	3
Amp rating	45A
Mechanical operating cycles	10,000,000
Internal/standard auxiliary contact:	
Number of NC / NO auxiliary contacts	0NC / 1NO
Rating	10A@600VAC (A600), 5A@600VDC (P600)
Optional auxiliary contact:	
Max number of NC / NO auxiliary contacts	7 total
Rating	10A@600VAC (A600), 5A@600VDC (P600)
Coil:	
Voltage	110–120/220–240VAC 60Hz Coil
Sealed watts	8.6W
Inrush / sealed power	218 / 25 VA
Normal coil operating limits (% of rated voltage)	85% - 110%
Typical drop-out volts (% of rated voltage)	50%
Pick-up time / Drop-out time	19-29 / 10-24 msec
Overload Relay:	
Current range	13–52A
Trip Class	Class 5 / 10 / 20 (factory set) / 30
Trip detection	Overload, phase failure, phase unbalance, ground fault
Phase failure sensitivity	Trip time after phase-loss: < 3 sec
Repeat accuracy	Within 1%
Reset options	Manual, automatic and remote
External reset	No
Test function	Electronics & manual actuation
Conformal coating on printed circuit board	Yes
Number of NC / NO auxiliary contacts	1NC / 1NO
Rating of auxiliary contacts	5A@600VAC (B600), 1A@250VDC (R300)
Single contact isolation	600V

Dual contact isolation	300V differing polarity / 600V common polarity
Enclosure:	
Type	Open device (no enclosure)
Rating	NA
Mounting/wiring:	
Mounting orientation	Vertical
Mounting type	Surface
Line side connection type / torque	Box lug / 45 lb-in.
Line side solid & stranded conductors	1x(14 - 2 AWG) 75°C AL or CU
Load side connection type / torque	Box lug / 45 lb-in.
Load side solid & stranded conductors	1x(14 - 2 AWG) 75°C AL or CU
Coil connection type / torque	Screw / 5 lb in. - 12 lb in.
Coil solid & stranded conductors	2 x (16 - 12 AWG) CU 60/75°C
Main auxiliary contact connection type / torque	Screw / 10 - 15 lb-in
Main auxiliary contact solid & stranded conductors	1 x (12 AWG), 2 x (16 - 14 AWG), 2 x (18 - 16 AWG) 75°C CU
OLR auxiliary contact connection type / torque	Screw / 7 lb in. - 10 lb in.
OLR auxiliary contact solid & stranded conductors	2 x (20 - 14 AWG) CU 60/75°C
Short circuit current rating:	
Fuses	10kA@600V (Class H or K); 100kA@600V (Class R or J)
Thermal Magnetic Circuit Breaker	14kA@240V; 10kA@600V
Certificates/approvals:	
	UL (file no. E14900) cUL (file no. E14900 for Canada) CSA (file no. LR 6535) ISO 9001 certification
Additional information:	
	Brochure OLR instruction sheet & trip curves

OUTLINE NEMA SIZE 2 - 2 1/2 CLASS 14 STARTER



DIMENSIONS ARE IN INCHES [MILLIMETERS]
 FILE NAME: D38235002

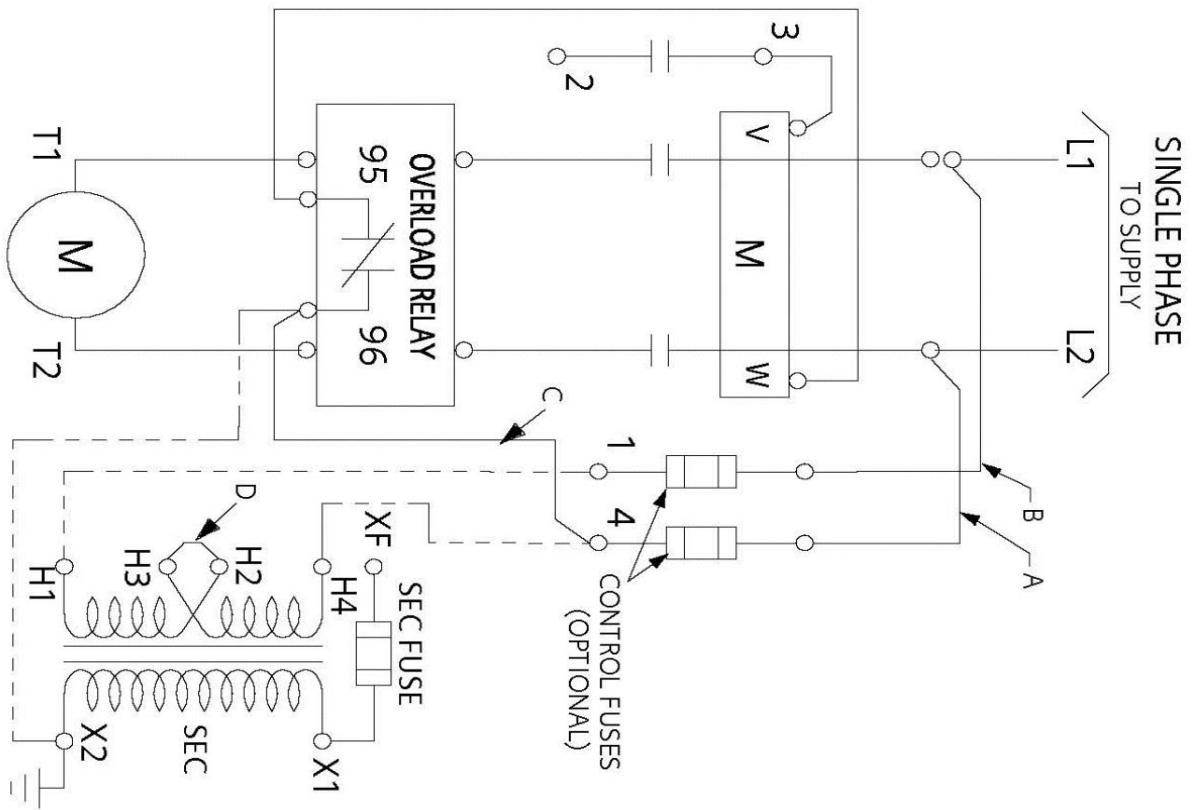
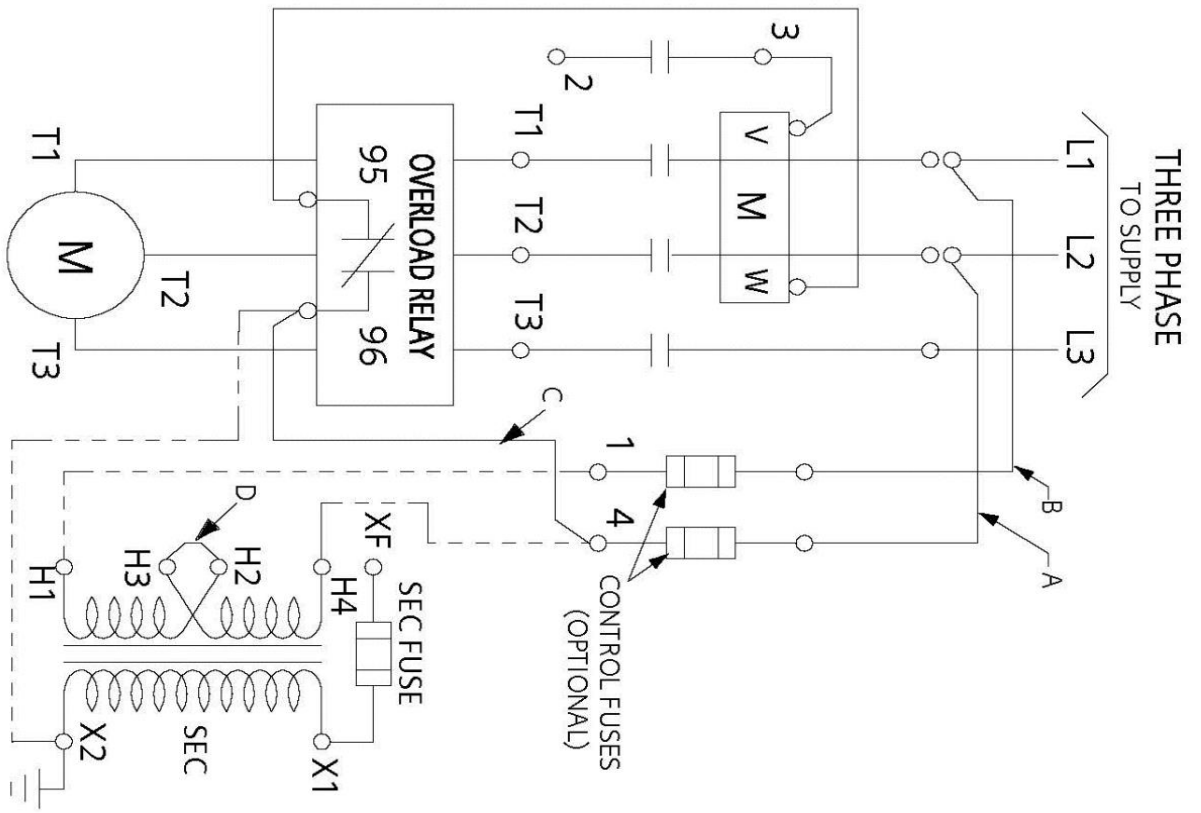

REF. D46590001