



HS442

S4424

Industry Standards
UL 870
NEMA/EEMAC Type 1

UL Files E32576

CSA File LL66078

FEATURES-SPECIFICATIONS

Applications

Designed to protect electrical wiring in applications where dirt, dust, oil and water are not serious problems. All sections are open on one side so wires and cable can be laid in along an entire wireway run.

A complete selection of sections and fittings is offered in five sizes:

2.50" x 2.50" (64 x 64)
4.00" x 4.00" (102 x 102)
6.00" x 6.00" (152 x 152)
8.00" x 8.00" (203 x 203)
10.00" x 10.00" (255 x 255)*
12.00" x 12.00" (305 x 305)**

Construction

- 2.50" x 2.50" (64 x 64), 4.00" x 4.00" (102 x 102) 6.00" x 6.00" (152 x 152) bodies and covers are fabricated from 16 gauge steel
- 8.00" x 8.00" (203 x 203), 10.00" x 10.00" (255 x 255), 12.00" x 12.00" (305 x 305) bodies and covers are fabricated from 14 gauge steel
- Available with or without knockouts in all sizes except the 10.00" x 10.00" (255 x 255) and 12.00" x 12.00" (305 x 305) which are available without knockouts only (See knockout pattern chart)

- HS Series combination hinge/screw cover design offers easy access to open top for "lay-in" of wireway. Screws do not need to be removed to open top
- S Series screw cover design covers held firmly in place with captivated screw fasteners
- Straight sections with knockouts are provided on side walls on wireways

Finish

- ANSI 61 gray polyester powder inside and out over phosphatized surfaces
- Pre-galvanized steel is unpainted

| HS & S SERIES WIREWAYS (STRAIGHT SECTIONS) | | | | | | | | | | |
|--|----------------------|----------------------------|----------------------|----------------------------|----------------------|----------------------------|----------------------|-------------------------------|--------------------------------|----------------|
| CATALOG NUMBER | | | | | | | | | | LENGTH |
| 2.50 x 2.50 (64 x 64) | | 4.00 x 4.00 (102 x 102) | | 6.00 x 6.00 (152 x 152) | | 8.00 x 8.00 (203 x 203) | | 10.00 x 10.00* (254 x 254) | 12.00 x 12.00** (305 x 305) | |
| WITH KNOCKOUTS | WITHOUT KNOCKOUTS | WITH KNOCKOUTS | WITHOUT KNOCKOUTS | WITH KNOCKOUTS | WITHOUT KNOCKOUTS | WITH KNOCKOUTS | WITHOUT KNOCKOUTS | WITHOUT KNOCKOUTS | WITHOUT KNOCKOUTS | |
| HINGE COVER | | | | | | | | | | |
| HS221 | HS221NK | HS441 | HS441NK | HS661 | HS661NK | HS881 | HS881NK | — | HS12121NK | 12.00" (305) |
| HS222 | HS222NK | HS442 | HS442NK | HS662 | HS662NK | HS882 | HS882NK | — | HS12122NK | 24.00" (610) |
| HS223 | HS223NK | HS443 | HS443NK | HS663 | HS663NK | HS883 | HS883NK | — | HS12123NK | 36.00" (914) |
| HS224 | HS224NK | HS444 | HS444NK | HS664 | HS664NK | HS884 | HS884NK | — | HS12124NK | 48.00" (1219) |
| HS225 | HS225NK | HS445 | HS445NK | HS665 | HS665NK | HS885 | HS885NK | — | HS12125NK | 60.00" (1524) |
| HS226 | HS226NK | HS446 | HS446NK | HS666 | HS666NK | HS886 | HS886NK | — | HS12126NK | 72.00" (1829) |
| HS2210 | HS2210NK | HS4410 | HS4410NK | HS6610 | HS6610NK | HS8810 | HS8810NK | — | HS121210NK | 120.00" (3048) |
| SCREW COVER | | | | | | | | | | |
| S2212 | S2212NK | S4412 | S4412NK | S6612 | S6612NK | S8812 | S8812NK | S101012NK | S121212NK | 12.00" (305) |
| S2224 | S2224NK | S4424 | S4424NK | S6624 | S6624NK | S8824 | S8824NK | S101024NK | S121224NK | 24.00" (610) |
| S2236 | S2236NK | S4436 | S4436NK | S6636 | S6636NK | S8836 | S8836NK | S101036NK | S121236NK | 36.00" (914) |
| S2248 | S2248NK | S4448 | S4448NK | S6648 | S6648NK | S8848 | S8848NK | S101048NK | S121248NK | 48.00" (1219) |
| S2260 | S2260NK | S4460 | S4460NK | S6660 | S6660NK | S8860 | S8860NK | S101060NK | S121260NK | 60.00" (1524) |
| S2272 | S2272NK | S4472 | S4472NK | S6672 | S6672NK | S8872 | S8872NK | S101072NK | S121272NK | 72.00" (1829) |
| S22120 | S22120NK | S44120 | S44120NK | S66120 | S66120NK | S88120 | S88120NK | S1010120NK | S1212120NK | 120.00" (3048) |
| S SERIES WIREWAYS (STRAIGHT SECTION) GALVANIZED | | | | | | | | | | |
| S2212G | S2212GNK | S4412G | S4412GNK | S6612G | S6612GNK | S8812G | S8812GNK | S101012GNK | S121212GNK | 12.00" (305) |
| S2224G | S2224GNK | S4424G | S4424GNK | S6624G | S6624GNK | S8824G | S8824GNK | S101024GNK | S121224GNK | 24.00" (610) |
| S2236G | S2236GNK | S4436G | S4436GNK | S6636G | S6636GNK | S8836G | S8836GNK | S101036GNK | S121236GNK | 36.00" (914) |
| S2248G | S2248GNK | S4448G | S4448GNK | S6648G | S6648GNK | S8848G | S8848GNK | S101048GNK | S121248GNK | 48.00" (1219) |
| S2260G | S2260GNK | S4460G | S4460GNK | S6660G | S6660GNK | S8860G | S8860GNK | S101060GNK | S121260GNK | 60.00" (1524) |
| S2272G | S2272GNK | S4472G | S4472GNK | S6672G | S6672GNK | S8872G | S8872GNK | S101072GNK | S121272GNK | 72.00" (1829) |
| S22120G | S22120GNK | S44120G | S44120GNK | S66120G | S66120GNK | S88120G | S88120GNK | S1010120GNK | S1212120GNK | 120.00" (3048) |

* 10" x 10" S SERIES only. Not UL listed. (Consult factory for dimensions and drawings for 10" x 10" wireway straight sections.)

** 12" x 12" not UL Listed. (Consult factory for dimensions and drawings for 12" x 12" wireway straight sections.)



| HS & S SERIES WIREWAY ACCESSORIES | | | | | | |
|-----------------------------------|----------------------------|----------------------------|----------------------------|-------------------------------|-------------------------------|------------------------------|
| CATALOG NUMBER | | | | | | DESCRIPTION |
| 2.50 x 2.50 (64 x 64) | 4.00 x 4.00 (102 x 102) | 6.00 x 6.00 (152 x 152) | 8.00 x 8.00 (203 x 203) | 10.00 x 10.00* (254 x 254) | 12.00 x 12.00* (305 x 305) | |
| E0202 | E0404 | E0606 | E0808 | — | — | End caps (with knockouts) |
| E0202NK | E0404NK | E0606NK | E0808NK | E1010NK | E1212NK | End caps (without knockouts) |
| T0202 | T0404 | T0606 | T0808 | T1010 | T1212 | Tee |
| X0202 | X0404 | X0606 | X0808 | X1010 | X1212 | Cross |
| AF0202 | AF0404 | AF0606 | AF0808 | AF1010 | AF1212 | Telescope |
| C0202 | C0404 | C0606 | C0808 | C1010 | C1212 | Connectors |
| PA0202 | PA0404 | PA0606 | PA0808 | PA1010 | PA1212 | Panel-Adapter |
| BH0202 | BH0404 | BH0606 | BH0808 | BH1010 | BH1212 | Bracket Hanger |
| — | R0402 | R0604 | R0806 | R1008 | R1208 | Reducer |
| SL020290 | SL040490 | SL060690 | SL080890 | SL101090 | SL121290 | Sweep Elbow – 90° |
| L020290 | L040490 | L060690 | L080890 | L101090 | L121290 | Elbow – 90° |
| L020245 | L040445 | L060645 | L080845 | L101045 | L121245 | Elbow – 45° |
| S SERIES ACCESSORIES (GALVANIZED) | | | | | | |
| — | E0404G | E0606G | E0808G | — | — | End caps (without knockouts) |
| E0202GNK | — | — | — | E1010GNK | E1212GNK | End caps (with knockouts) |
| T0202G | T0404G | T0606G | T0808G | T1010G | T1212G | Galvanized Tee |
| X0202G | X0404G | X0606G | X0808G | X1010G | X1212G | Galvanized Cross |
| AF0202G | AF0404G | AF0606G | AF0808G | AF1010G | AF1212G | Galvanized Telescope |
| C0202G | C0404G | C0606G | C0808G | C1010G | C1212G | Galvanized Connectors |
| PA0202G | PA0404G | PA0606G | PA0808G | PA1010G | PA1212G | Galvanized Panel-Adapter |
| BH0202G | BH0404G | BH0606G | BH0808G | BH1010G | BH1212G | Galvanized Bracket Hanger |
| — | R0402G | R0604G | R0806G | R1008G | R1208G | Galvanized Reducer |
| SL020290G | SL040490G | SL060690G | SL080890G | SL101090G | SL121290G | Galvanized Sweep Elbow – 90° |
| L020290G | L040490G | L060690G | L080890G | L101090G | L121290G | Galvanized Elbow – 90° |
| L020245G | L040445G | L060645G | L080845G | L101045G | L121245G | Galvanized Elbow – 45° |

| HS SERIES 2" STRAIGHT SECTION DIMENSIONS | | | |
|--|---------------|------------|-------------|
| CATALOG NUMBER | A | B | C |
| HS221 & HS221NK | 12.00 (300) | — | 3.00 (75) |
| HS222 & HS222NK | 24.00 (600) | 1.00 (25) | 7.00 (175) |
| HS223 & HS223NK | 36.00 (900) | 2.00 (50) | 11.00 (275) |
| HS224 & HS224NK | 48.00 (1200) | 3.00 (75) | 15.00 (375) |
| HS225 & HS225NK | 60.00 (1500) | 4.00 (100) | 19.00 (475) |
| HS226 & HS226NK | 72.00 (1800) | 5.00 (125) | 23.00 (575) |
| HS2210 & HS2210NK | 120.00 (3000) | 9.00 (225) | 39.00 (975) |

NK = No Knockouts

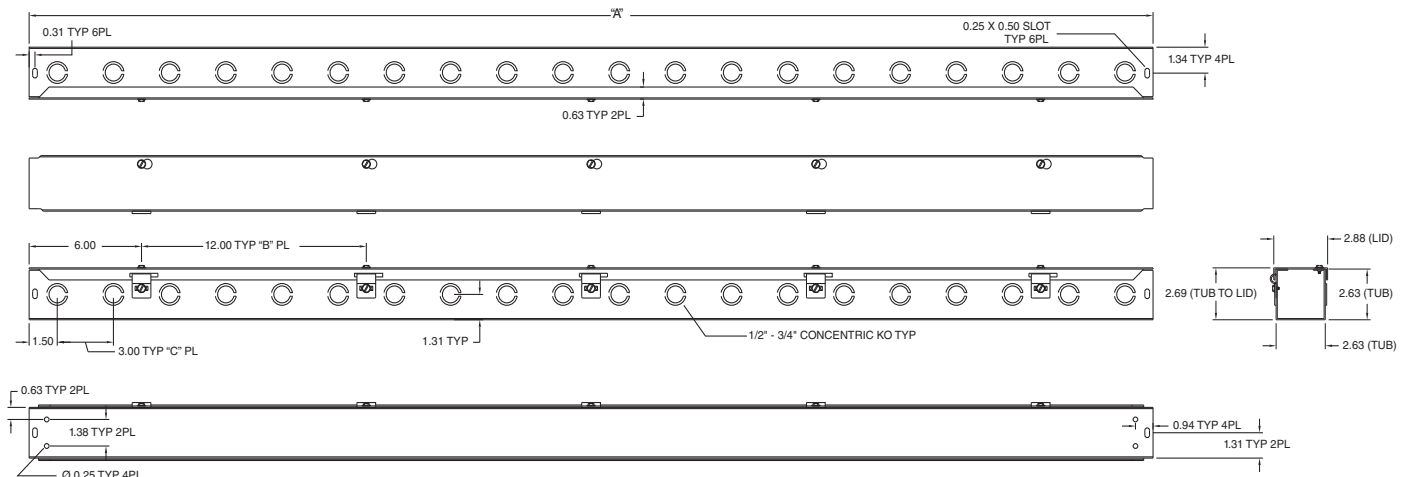

HS SERIES 2" STRAIGHT SECTION DIMENSIONS



| HS & S SERIES ACCESSORIES DIMENSIONS | | | | | | | | | | |
|--------------------------------------|-------------|------------|-------------|-------------|-------------|------------|------------|-------------|-------------|------------|
| A X B | G | H | J | K | L | M | N | O | P | Q |
| 2.50x2.50 (64x64) | 4.5 (114) | 2.75 (70) | 7.91(201) | 7.75 (197) | 4.63 (117) | 3.31 (84) | 3.25 (83) | 3.75 (95) | 6.5 (165) | — |
| 4.00x4.00 (102x102) | 6.00 (152) | 3.38 (86) | 9.41 (239) | 10.75 (273) | 6.13 (153) | 4.06 (103) | 4.00 (102) | 5.25 (133) | 8.00 (203) | — |
| 6.00x6.00 (152x152) | 8.00 (152) | 4.25 (108) | 11.34 (288) | 14.75 (375) | 8.13 (206) | 3.28 (83) | 5.00 (127) | 7.25 (184) | 10.00 (254) | 6.84 (174) |
| 8.00x8.00 (203x203) | 10.00 (254) | 5.06 (129) | 13.44 (341) | 18.75 (476) | 10.13 (257) | 3.28 (83) | 6.00 (152) | 9.25 (235) | 12.00 (305) | 8.84 (225) |
| 12.00x12.00 (305x305) | 14.00 (356) | 6.75 (171) | 17.44 (443) | 56.75 (679) | 14.13 (359) | 6.25 (159) | 8.00 (203) | 13.25 (337) | 16.00 (406) | 9.88 (251) |

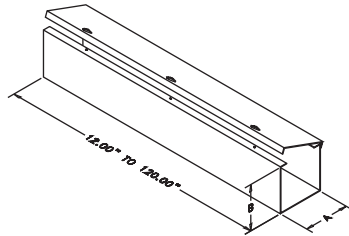

Straight Section

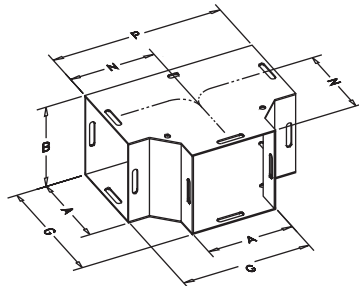

Tee

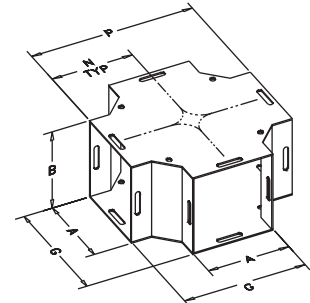

Cross

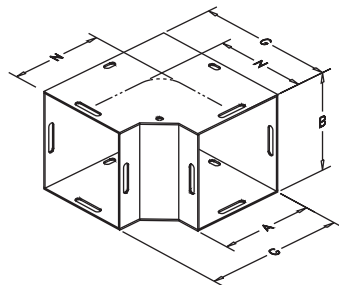

90° Elbow

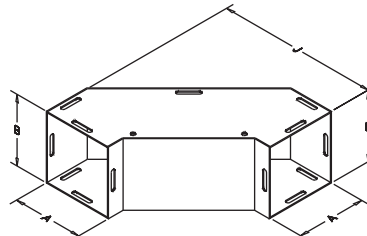

Sweep Elbow

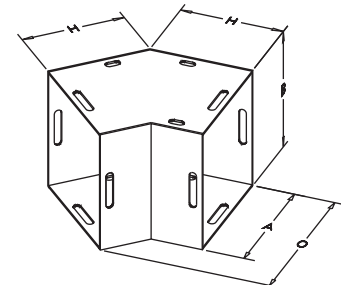

45° Elbow

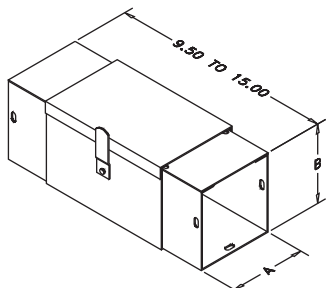

Telescope Fitting

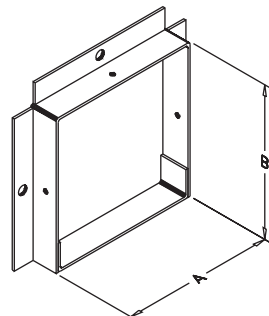

Panel Adapter

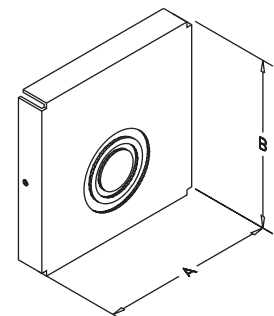

End Cap

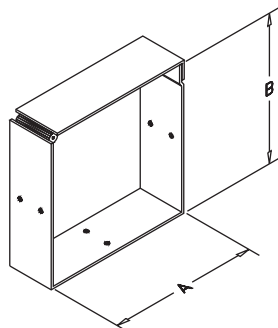

Connector

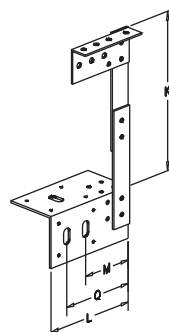

Combination Hanger

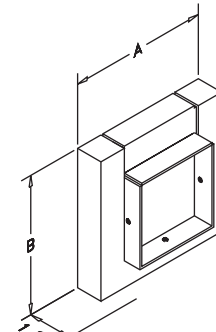

Reducer