

Dimensions / Data

30" x 48" PG Style Polymer Concrete (Stackable) Assembly

Hex Head Bolts are Standard

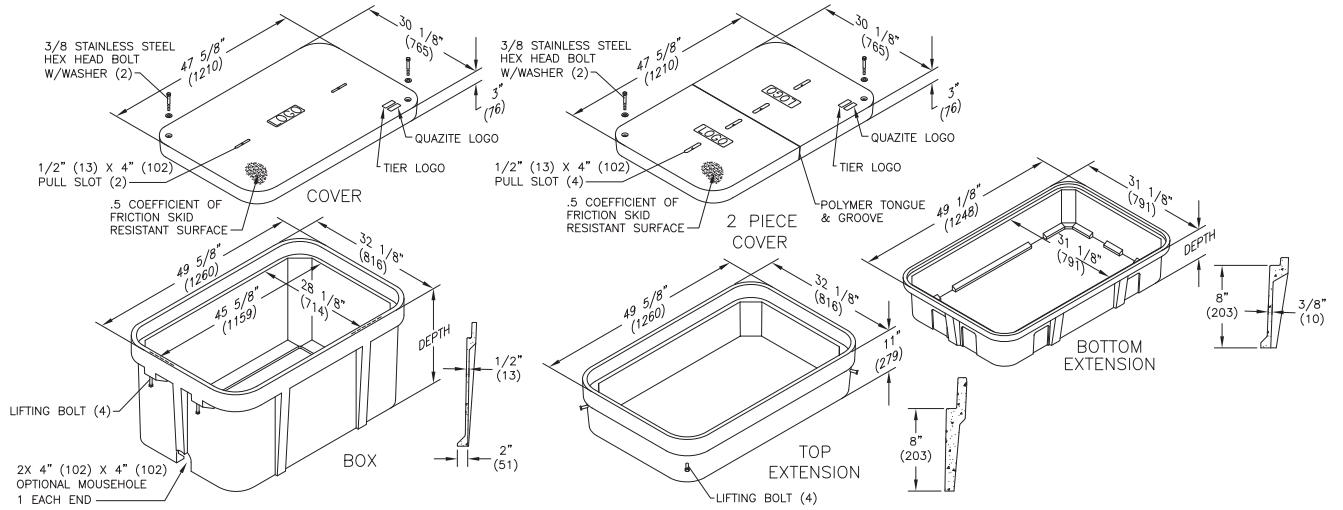

Covers

	DESCRIPTION	TIER	DESIGN / TEST LOAD #	WEIGHT #	PALLET QTY	PART NO.
UL	W/ 2 Bolts	8	8,000 / 12,000	159	10	PG3048CA00**
	2 piece w/2 Bolts	8	8,000 / 12,000	181	10	PG3048CS00**
UL	W/ 2 Bolts	15	15,000 / 22,500	206	10	PG3048HA00**
UL	2 piece w/2 Bolts	15	15,000 / 22,500	206	10	PG3048HS00**
UL	W/ 2 Bolts	22	22,500 / 33,750	220	10	PG3048HH00**
UL	No Bolts	8	8,000 / 12,000	159	10	PG3048WA00**

To order gasketed covers, replace the letter "A" with the letter "G".

Replace ** with a logo code found on page 18.







NOTE: Gasketed covers and bolt grommets must be used with a gasketed box. Gaskets reduce the inflow of fluids but do not make the enclosure water tight.

QUAZITE

Dimensions / Data 30" x 48" PG Style Polymer Concrete (Stackable) Assembly (Continued)

Hex Head Bolts are Standard

Boxes (Box depths 24" thru 48" must be used as bottom of any stack)

DESCRIPTION	DEPTH	TIER	DESIGN / TEST LOAD #	WEIGHT #	PALLET QTY	PART NO.
   Standard Open Bottom	18"	22	22,500 / 33,750	185	4	PG3048BA18
	24"		22,500 / 33,750	236	3	PG3048BA24
	36"		22,500 / 33,750	343	2	PG3048BA36
	48"		22,500 / 33,750	450	1	PG3048BA48
   Solid Bottom	18 1/2"	22	22,500 / 33,750	220	4	PG3048DA18
	24 1/2"		22,500 / 33,750	287	3	PG3048DA24
	36 1/2"		22,500 / 33,750	394	2	PG3048DA36
	48"		22,500 / 33,750	501	1	PG3048DA48

To order boxes with 2 standard mouseholes, replace the letter "A" with the letter "B".
 To order gasketed boxes, replace the letter "A" with the letter "G".
 NOTE: Gasketed covers and bolt grommets must be used with a gasketed box. Gaskets reduce the inflow of fluids but do not make the enclosure water tight.

Top Extension

DESCRIPTION	DEPTH	TIER	DESIGN / TEST LOAD #	WEIGHT #	PALLET QTY	PART NO.
Open bottom	11"	22	22,500 / 33,750	100	8	PG3048EA11

Bottom Extensions (for use under 18" box only, one per box)

DESCRIPTION	DEPTH	TIER	DESIGN / TEST LOAD #	WEIGHT #	PALLET QTY	PART NO.
Open bottom	8 3/4"	22	22,500 / 33,750	102	8	PG3048EA08
Solid bottom	9 1/4"	22	22,500 / 33,750	151	8	PG3048RA08

QUAZITE